

MANISCOPIC

■ MT 732





- Lifting height : 6.90 m
- Capacity : 3200 kg
- Maximum forward reach : 4.16 m
- Torque convertor
- 4 wheel steer - 4 wheel drive

 **MANITOU**

MT 732

 **Lifting capacity**3200 kg
at 500 mm from forks heels.
Tipping load
at maximum reach :1620 kg
Tear out force with bucket
to ISO 8313.....8400 daN

 **Lifting height** :6.90 m
Times : unladen / loaded (in s)
Lifting6.7/7.3
Lowering5/4.7
Simultaneous extension6.3/6.8
Simultaneous retraction3.3/3
Time unladen (in s)
Crowd2.8
Dump2.3

 **Tyres**
400/80 - 24 156 A8 TL

 **Forks** (mm)
Length.....1200
Width x thickness.....125 X 45
Maximum distance between forks.....1040
Carriage rotation.....126°

 **Oil immersed multidisc brakes on both axes.**

 **Perkins Engine**
Type1104C-44
Capacity.....4 cyl. 4400 cm3
Power at 2200 rpm :84 hp/61.5 kw
(ISO/TR 14396)
Maximum torque :302 Nm at 1400 rpm
Direct injection
water cooling

 **Transmission**.....Torque Convertor
Electro - Hydraulic reversing shift
4 speeds forward and reverse
Maximum travel speed.....25 km/h

 **Hydraulics**
Lifting/tilting pump
gear type:240 bars/105 l/mn
Flow divider with priority to steering and brakes.

 **Capacities**
Cooling system.....18.5 l.
Engine oil.....10.5 l.
Hydraulic oil125 l.
Transmission oil15.5 l.
Fuel tank120 l.

 **Weight unladen** (with forks)7250 kg
Overall width2.26 m
Overall height2.30 m
Turning radius (outside wheels)3.67 m
Up to carriage length4.77 m
Ground clearance0.44 m
Drawbar pull.....8400 daN

Reach at maximum height : 1,15 m

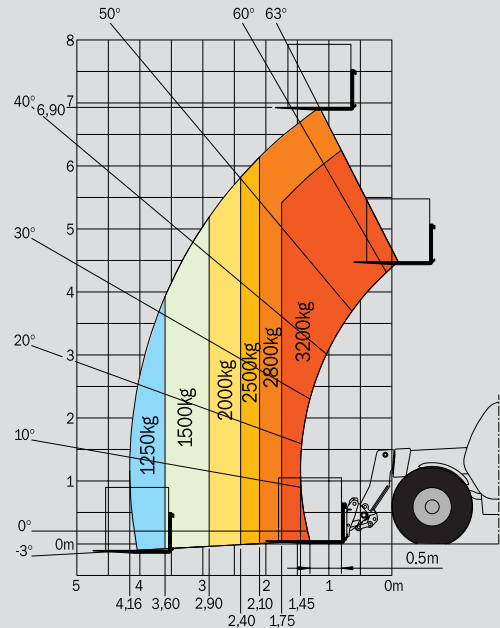

Under EN 1459 annexe B

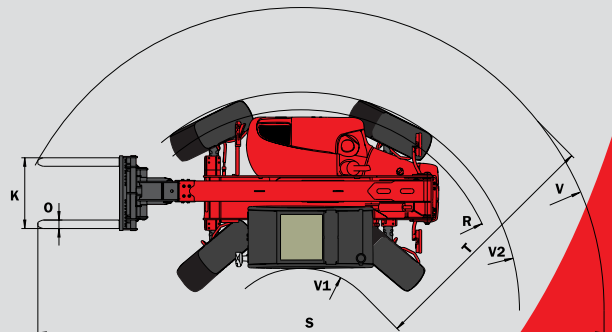
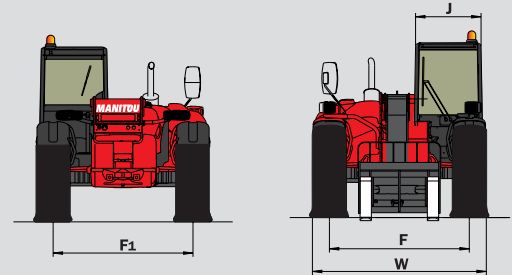
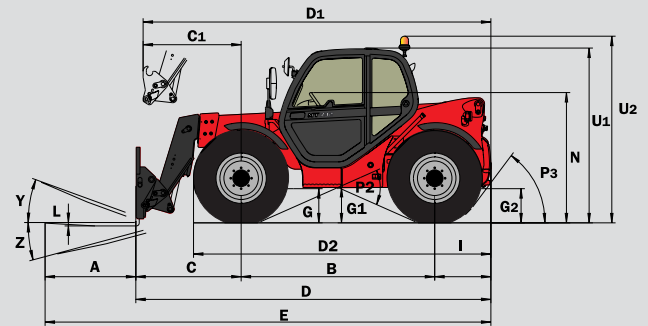

A	1200
B	2560
C	1444
C1	1537
D	4767
D1	4860
D2	3908
E	5967
F	1846
F1	1846
G	455
G1	440
G2	440
I	763
J	865
K	1040
L	45
N	1690
O	125
P2	47.5°
P3	53°
R	3460
S	7591
T	3555
U1	2300
U2	2550
V	4805
V1	1250
V2	3668
W	2261
Y	12°
Z	114°

mm

This publication in no way constitutes an offer and the company reserves the right to alter specification without prior notice.
The MANITOU models presented in this brochure can be supplied complete with optional equipment attachments.

